

スイッチング電源用トランス SW SERIES
Transformers for switching power supplies SW SERIES

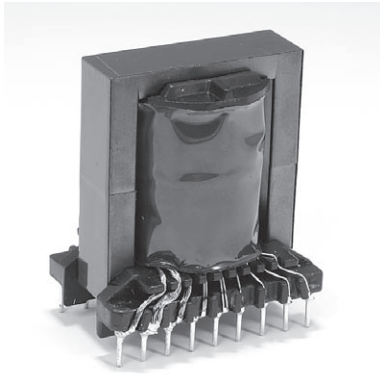

SW SERIES

RoHS

タムラのSWシリーズは、RoHS指令に適合しております。
SW series of Tamura conform to the command of RoHS.

- LOW COST!!
- 環境対応型製品!!
- LOW COST!!
- Types manufactured to fit for environmental factors!!

カタログ品番 Catalog No.	コアサイズ Core size	参考出力 Reference output (Flyback)
SW1312AT	EE13/12	5W(100KHz)
SW1515AF	EET15/15	3.5W(100KHz)
SW1610SAT	EE16/10	8W(100KHz)
SW1614T	EE16/14	8W(100KHz)
SW1614AT	EE16/14	8W(100KHz)
SW1919T	EE19/19	10W(100KHz)
SW2518AT	EI25/18	15W(100KHz)
SW2520T	EE25/20	20W(100KHz)
SW2820DT	EK28/20	25W(50KHz)
SW2821T	EE28/21	30W(100KHz)
SW2923DT	EED29/23	30W(50KHz)
SW2929T	EED29/29	40W(50KHz)
SW2834T	ER28/34	50W(50KHz)
SW2834PT	ER28/34	50W(50KHz)
SW2834F	ER28/34	50W(50KHz)
SW2828F	ER28/28	30W(50KHz)
SW3541T	ER35/41	80W(50KHz)
SW3541F	ER35/41	80W(50KHz)
SW3944T	ER39/44	100W(50KHz)
SW4045T	ER40/45	100W(50KHz)
SW4245T	ER42/45	160W(50KHz)
SW4245PT	ER42/45	160W(50KHz)
SW4245F	ER42/45	160W(50KHz)
SW4954T	ER49/54	240W(50KHz)
SW2620T	PQ26/20	75W(100KHz)
SW3218T	PQ32/18	150W(100KHz)
SW3220T	PQ32/20	180W(100KHz)
SW4023T	PQ40/23	250W(100KHz)

スイッチング電源用トランス SW SERIES
Transformers for switching power supplies SW SERIES

※丸数字はPIN番号 Figures in circles denote pin numbers.

SW1312AT

コアサイズ Core size	EE1312
参考出力 Reference output 100KHz	5W
最小コア断面積 Minimum core cross section (cm ²)	0.154
巻幅 / 巻高さ Coil width / coil height (mm)	7.8/2.825

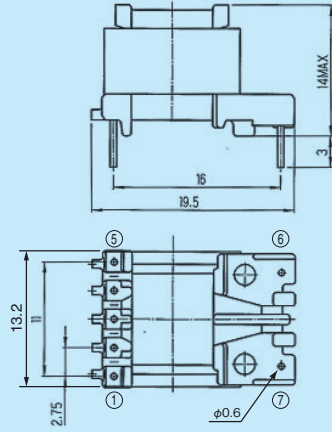

SW1614T

コアサイズ Core size	EE1614
参考出力 Reference output 100KHz	8W
最小コア断面積 Minimum core cross section (cm ²)	0.19
巻幅 / 巻高さ Coil width / coil height (mm)	8.15/2.78

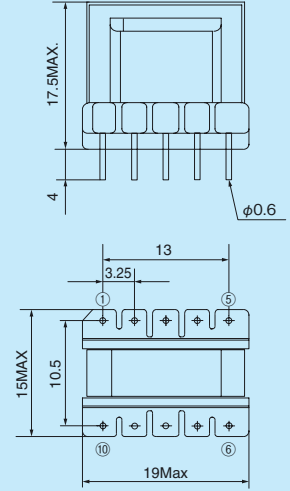

SW1515AF

コアサイズ Core size	EET1515
参考出力 Reference output 100KHz	3.5W
最小コア断面積 Minimum core cross section (cm ²)	0.135
巻幅 / 巻高さ Coil width / coil height (mm)	9.2/1.9

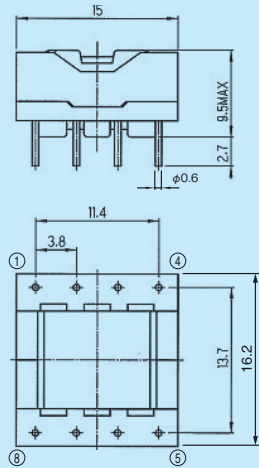

SW1614AT

コアサイズ Core size	EE1614
参考出力 Reference output 100KHz	8W
最小コア断面積 Minimum core cross section (cm ²)	0.19
巻幅 / 巻高さ Coil width / coil height (mm)	8.4 / 2.9

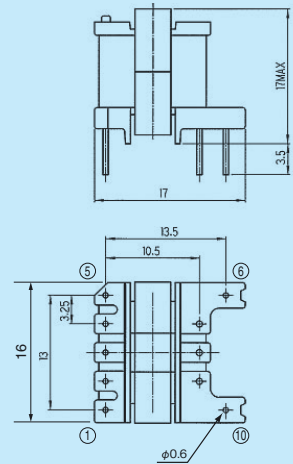

SW1610SAT

コアサイズ Core size	EE16/10
参考出力 Reference output 100KHz	8W
最小コア断面積 Minimum core cross section (cm ²)	0.399
巻幅 / 巻高さ Coil width / coil height (mm)	4.1/2.85

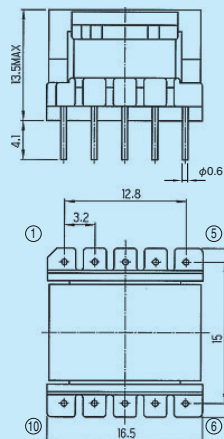

SW1919T

コアサイズ Core size	EE1919
参考出力 Reference output 100KHz	10W
最小コア断面積 Minimum core cross section (cm ²)	0.254
巻幅 / 巻高さ Coil width / coil height (mm)	9.6/2.6

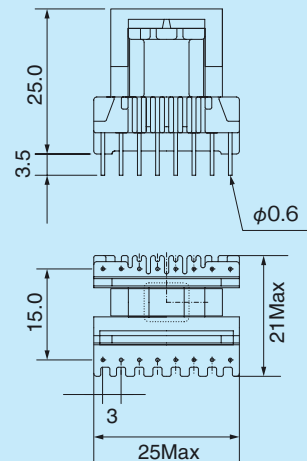

スイッチング電源用トランス SW SERIES
Transformers for switching power supplies SW SERIES

※丸数字はPIN番号 Figures in circles denote pin numbers.

SW2518AT

コアサイズ Core size	EI2518
参考出力 Reference output 100KHz	15W
最小コア断面積 Minimum core cross section (cm ²)	0.41
巻幅／巻高さ Coil width / coil height (mm)	9.9/4.15

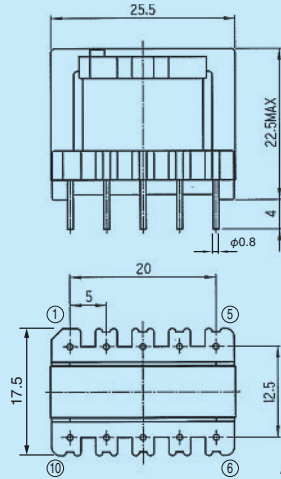

SW2821T

コアサイズ Core size	EE2821
参考出力 Reference output 100KHz	30W
最小コア断面積 Minimum core cross section (cm ²)	0.873
巻幅／巻高さ Coil width / coil height (mm)	10.3/4.6

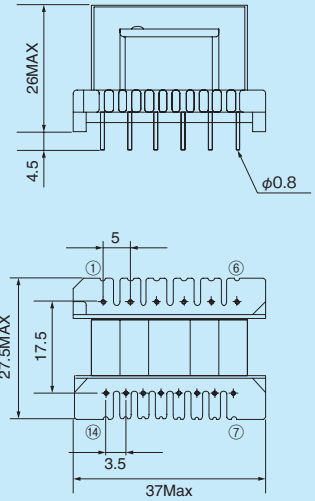

SW2520T

コアサイズ Core size	EE2520
参考出力 Reference output 100KHz	20W
最小コア断面積 Minimum core cross section (cm ²)	0.406
巻幅／巻高さ Coil width / coil height (mm)	10.7/5.9

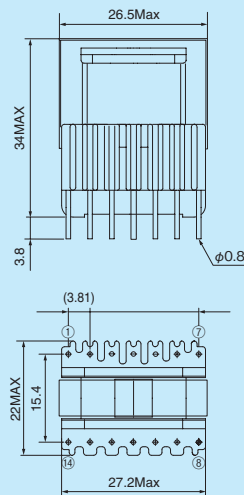

SW2923DT

コアサイズ Core size	EED2923
参考出力 Reference output 50KHz	30W
最小コア断面積 Minimum core cross section (cm ²)	0.841
巻幅／巻高さ Coil width / coil height (mm)	13.7/5.45

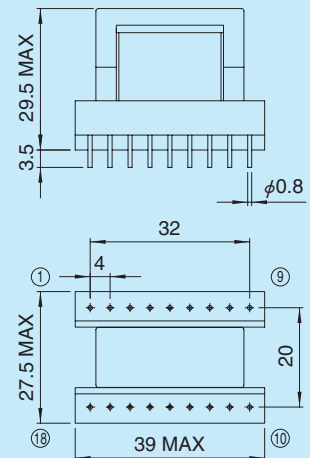

SW2820DT

コアサイズ Core size	EK2820
参考出力 Reference output 50KHz	25W
最小コア断面積 Minimum core cross section (cm ²)	0.81
巻幅／巻高さ Coil width / coil height (mm)	11.0/4.85

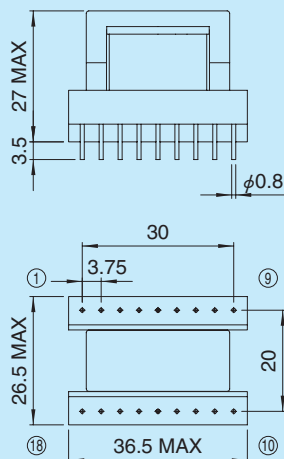

SW2929T

コアサイズ Core size	EED2929
参考出力 Reference output 50KHz	40W
最小コア断面積 Minimum core cross section (cm ²)	0.841
巻幅／巻高さ Coil width / coil height (mm)	19.7/5.45

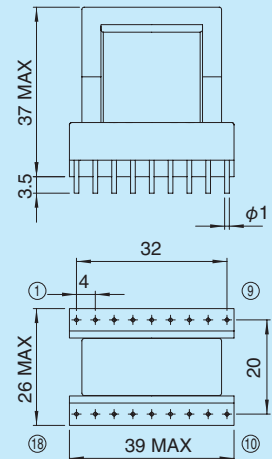

スイッチング電源用トランス SW SERIES
Transformers for switching power supplies SW SERIES

※丸数字はPIN番号 Figures in circles denote pin numbers.

SW2834T

コアサイズ Core size	ER2834
参考出力 Reference output 50KHz	50W
最小コア断面積 Minimum core cross section (cm ²)	0.854
巻幅／巻高さ Coil width / coil height (mm)	21.9/4.25

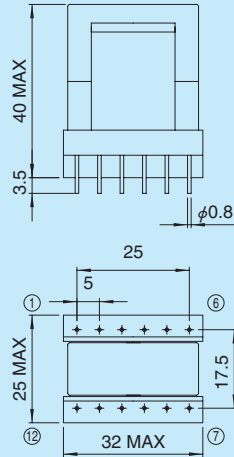

SW2828F

コアサイズ Core size	ER2828
参考出力 Reference output 50KHz	30W
最小コア断面積 Minimum core cross section (cm ²)	0.860
巻幅／巻高さ Coil width / coil height (mm)	16.5/4.40

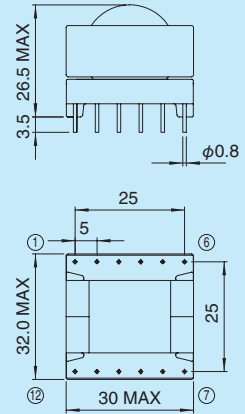

SW2834PT

コアサイズ Core size	ER2834
参考出力 Reference output 50KHz	50W
最小コア断面積 Minimum core cross section (cm ²)	0.854
巻幅／巻高さ Coil width / coil height (mm)	22.4/4.65

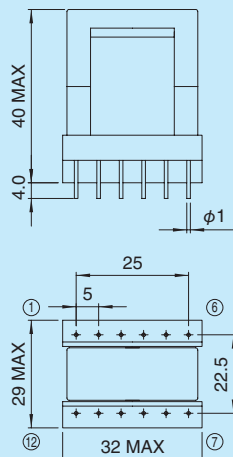

SW3541T

コアサイズ Core size	ER3541
参考出力 Reference output 50KHz	80W
最小コア断面積 Minimum core cross section (cm ²)	1.07
巻幅／巻高さ Coil width / coil height (mm)	26.4/5.90

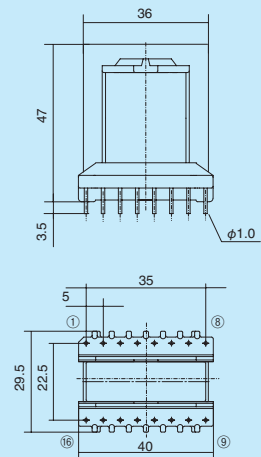

SW2834F

コアサイズ Core size	ER2834
参考出力 Reference output 50KHz	50W
最小コア断面積 Minimum core cross section (cm ²)	0.854
巻幅／巻高さ Coil width / coil height (mm)	22.3/4.40

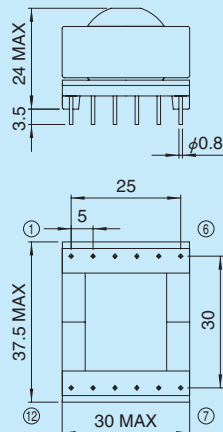

SW3541F

コアサイズ Core size	ER3541
参考出力 Reference output 50KHz	80W
最小コア断面積 Minimum core cross section (cm ²)	1.07
巻幅／巻高さ Coil width / coil height (mm)	26.5/5.95

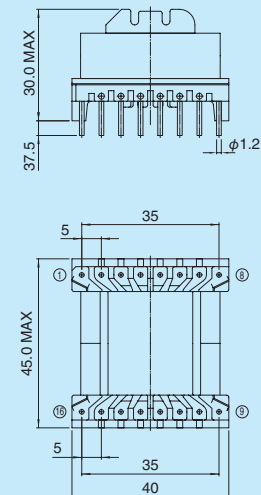

スイッチング電源用トランス SW SERIES
Transformers for switching power supplies SW SERIES

※丸数字はPIN番号 Figures in circles denote pin numbers.

SW3944T

コアサイズ Core size	ER3944
参考出力 Reference output 50KHz	100W
最小コア断面積 Minimum core cross section (cm ²)	1.30
巻幅 / 巻高さ Coil width / coil height (mm)	31.1/6.75

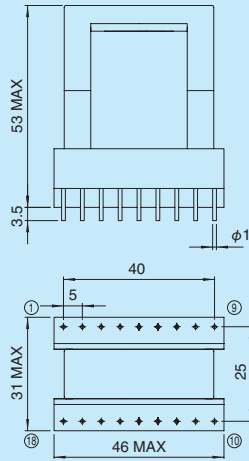

SW4245PT

コアサイズ Core size	ER4245
参考出力 Reference output 50KHz	160W
最小コア断面積 Minimum core cross section (cm ²)	1.82
巻幅 / 巻高さ Coil width / coil height (mm)	27.6/5.65

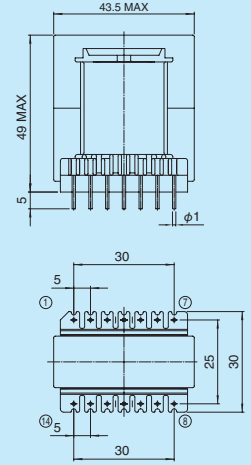

SW4045T

コアサイズ Core size	ER4045
参考出力 Reference output 50KHz	100W
最小コア断面積 Minimum core cross section (cm ²)	1.34
巻幅 / 巻高さ Coil width / coil height (mm)	27.8/6.55

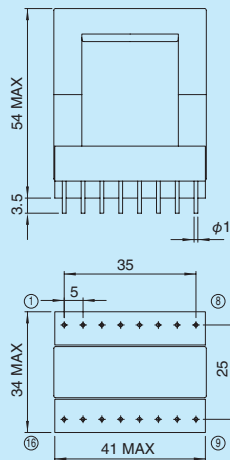

SW4245F

コアサイズ Core size	ER4245
参考出力 Reference output 50KHz	160W
最小コア断面積 Minimum core cross section (cm ²)	1.82
巻幅 / 巻高さ Coil width / coil height (mm)	27.7/5.80

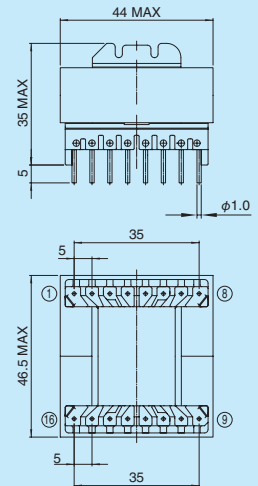

SW4245T

コアサイズ Core size	ER4245
参考出力 Reference output 50KHz	160W
最小コア断面積 Minimum core cross section (cm ²)	1.82
巻幅 / 巻高さ Coil width / coil height (mm)	27.6/5.75

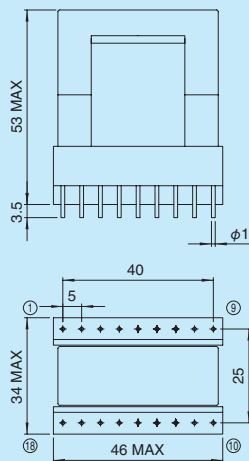

SW4954T

コアサイズ Core size	ER4954
参考出力 Reference output 50KHz	240W
最小コア断面積 Minimum core cross section (cm ²)	2.42
巻幅 / 巻高さ Coil width / coil height (mm)	33.8/8.30

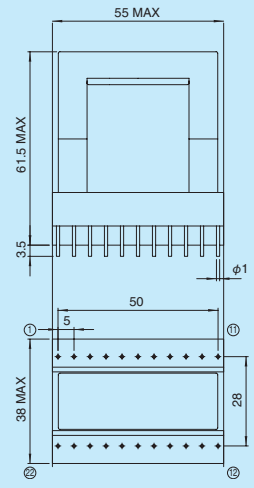

スイッチング電源用トランス SW SERIES
Transformers for switching power supplies SW SERIES

※丸数字はPIN番号 Figures in circles denote pin numbers.

SW2620T

コアサイズ Core size	PQ2620
参考出力 Reference output 100KHz	75W

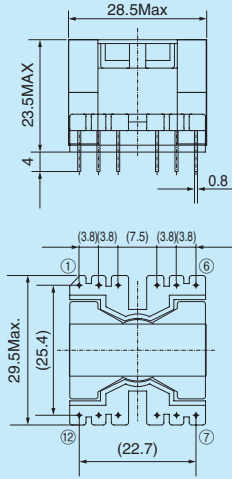

SW4023T

コアサイズ Core size	PQ4023
参考出力 Reference output 100KHz	250W

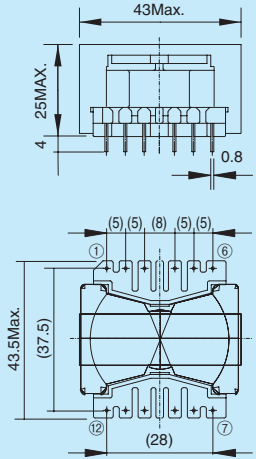

SW3218T

コアサイズ Core size	PQ3218
参考出力 Reference output 100KHz	150W

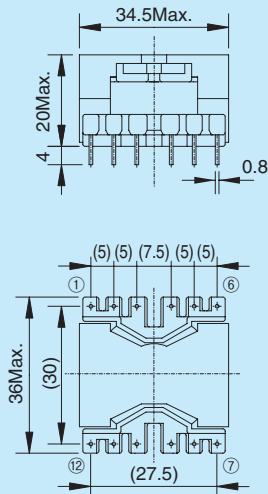

SW3220T

コアサイズ Core size	PQ3220
参考出力 Reference output 100KHz	180W

